

TECHNICAL DATA SHEET

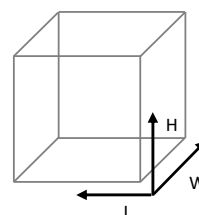
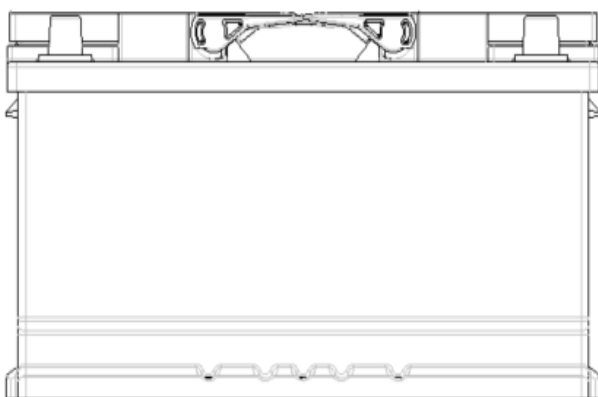
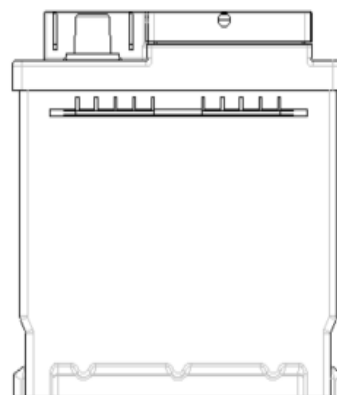
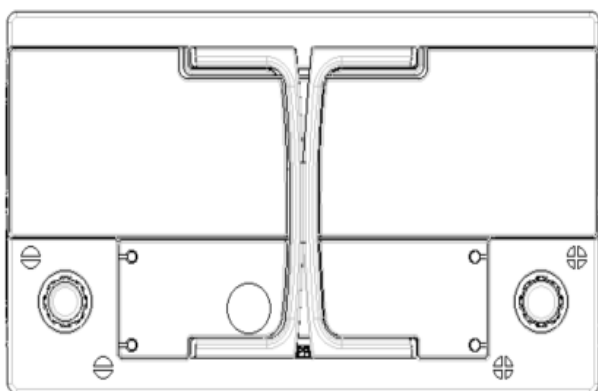

PERFORMANCE			CONTAINER		
VOLTAGE:	12	V	Group:	LB4	L.Gray
C20:	80	Ah	Hold Down:	B13	
CCA:	800	EN	Please refer to the catalog or our website for the details of hold down types of the battery container.		
Vibration:	V3		COVER		
Endurance:	E1		Type:	Heat sealed	L.Gray
Water consumption:	W4		Polarity:	L	
Technology:	Flooded		Terminals:	Standard	
Grid alloy:	Ca/Ca		Filter:	2 Filters both sides	
WEIGHT AND STD. DIMENSION			HANDLES		
Battery weight:	19,2	kg	Handles:	2 handles	
Volume acid:	4,6	l	REMARK		
Length:	315	mm			
Width:	174	mm			
Height:	175	mm			
Total Height:	175	mm			